

ELASTECH

IEP160x50-Ø20

EAN 4031582319705

알루미늄으로 만든 휠 중심, 트레드: 검정색 탄성 타이어, 경화 처리, 정밀 볼 베어링



BETTER MOBILITY. BETTER LIFE.



Picture may differ from original product

기술 데이터

휠 직경	160 mm
휠 폭	50 mm
축 홀-Ø	20 mm
허브 길이	60 mm
온도	- 20 / + 85 °C
표준	EN 12532
무게	1.31 kg
트레드 경도	Shore A 68
동하중	350 kg
정지하중	700 kg

Dimensions

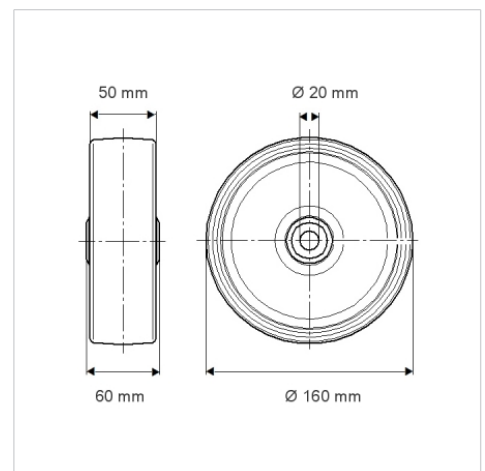

Advantages at a glance

롤 저항성	● ● ● ○ ○
이동 소음	● ● ● ○ ○
마찰	● ● ● ○ ○
부식 방지	● ● ● ○ ○

Structure & Mounting

