

ELASTECH

IEP200x50-Ø20

EAN 4031582319736

Hjulfælg: Aluminium, Hjulbane: Elastisk sort gummi, vulkaniseret, DIN-kugleleje



BETTER MOBILITY. BETTER LIFE.



Illustrationen kan afvige fra originalen

Tekniske data

Hjul-Ø	200 mm
Hjulbredde	50 mm
Boring-Ø	20 mm
Navlængde	60 mm
Temperaturinterval	- 20 / + 85 °C
Standard	EN 12532
Vægt	1.75 kg
Hjulbane hårdhed	Shore A 68
Belastning (dynamisk)	450 kg
Belastning (statisk)	900 kg

Dimensioner

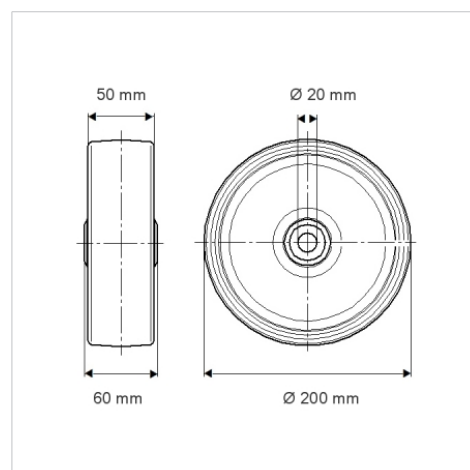

Egenskaber/fordele

Rullemodstand	● ● ● ○ ○
Kørselsstøj	● ● ● ○ ○
Slid	● ● ● ○ ○
Rustbeskyttelse	● ● ● ○ ○

Struktur og montering

