

NOVATECH

ITP100x50-Ø20 flat

EAN 4031582070309

Wheel centre made of Aluminium, Tread: Polyurethane, casted, precision ball bearing



BETTER MOBILITY. BETTER LIFE.



Picture may differ from original product

Technical Data

Wheel diameter	100 mm
Wheel width	50 mm
Axle Hole-Ø	20 mm
Hub length	60 mm
Temperature	- 10 / + 60 °C
Standard	EN 12532
Weight	0.62 kg
Hardness of tread	Shore D 42
Load capacity	540 kg
Load capacity (static)	1080 kg

Dimensions

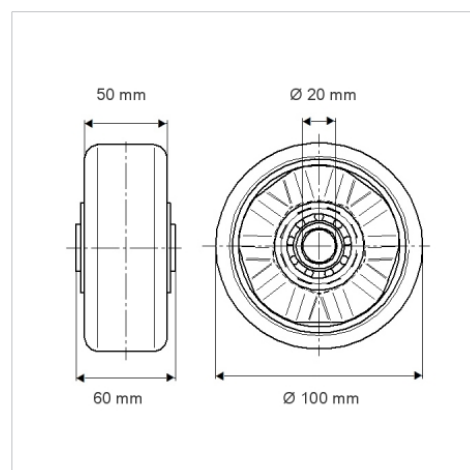

Advantages at a glance

Roll performance	● ● ● ○ ○
Movement noise	● ● ● ○ ○
Attrition	● ● ● ● ○
Corrosion resistance	● ● ● ○ ○

Structure & Mounting

