

NOVATECH

ITP100x50-Ø20 flat

EAN 4031582070309

Jantă din aluminiu, suprafață de rulare din poliuretan, rulment de precizie

TENTE

BETTER MOBILITY. BETTER LIFE.



Picture may differ from original product

Date Tehnice

Diametrul roții	100 mm
Lățimea roții	50 mm
Alezaj butuc	20 mm
Lungime butuc	60 mm
Temperatura	- 10 / + 60 °C
Standard	EN 12532
Greutate	0.62 kg
Rigiditatea suprafeței de rulare	Shore D 42
Sarcină dinamică	540 kg
Sarcină statică	1080 kg

Dimensions

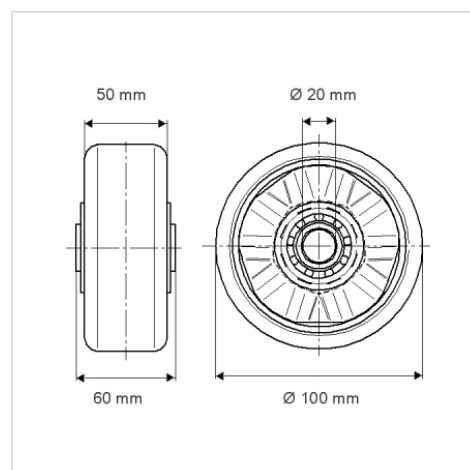

Advantages at a glance

Rezistență la rulare	● ● ● ○ ○
Zgomot de mișcare	● ● ● ○ ○
Uzare	● ● ● ● ○
Protecție împotriva ruginii	● ● ● ○ ○

Structure & Mounting

