

# NOVATECH

## ITP125x50-Ø20 flat

EAN 4031582070316

Hjulfælg: Aluminium, Hjulbane: Polyuretan, DIN-kugleleje



BETTER MOBILITY. BETTER LIFE.



Illustrationen kan afvige fra originalen

### Tekniske data

Hjul-Ø	125 mm
Hjulbredde	50 mm
Boring-Ø	20 mm
Navlængde	60 mm
Temperaturinterval	- 10 / + 60 °C
Standard	EN 12532
Vægt	0.85 kg
Hjulbane hårdhed	Shore D 42
Belastning (dynamisk)	500 kg
Belastning (statisk)	1000 kg

### Dimensioner

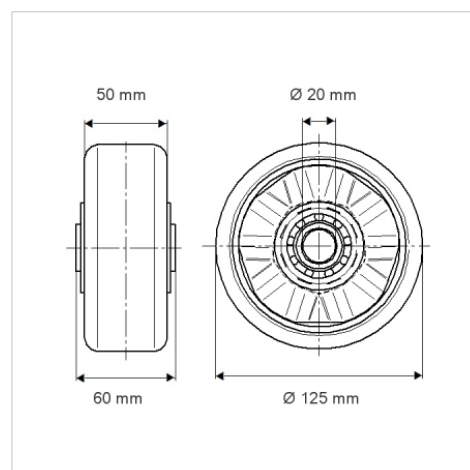

### Egenskaber/fordele

Rullemodstand	● ● ● ○ ○
Kørselsstøj	● ● ● ○ ○
Slid	● ● ● ● ○
Rustbeskyttelse	● ● ● ○ ○

### Struktur og montering

