

# NOVATECH

ITP125x50-Ø20 flat

EAN 4031582070316

알루미늄으로 만든 휠 중심, 트레드: 폴리우레탄, 주조 처리, 정밀 볼 베어링



BETTER MOBILITY. BETTER LIFE.



Picture may differ from original product

## 기술 데이터

휠 직경	125 mm
휠 폭	50 mm
축 홀-Ø	20 mm
허브 길이	60 mm
온도	- 10 / + 60 °C
표준	EN 12532
무게	0.85 kg
트레드 경도	Shore D 42
동하중	500 kg
정지하중	1000 kg

## Dimensions

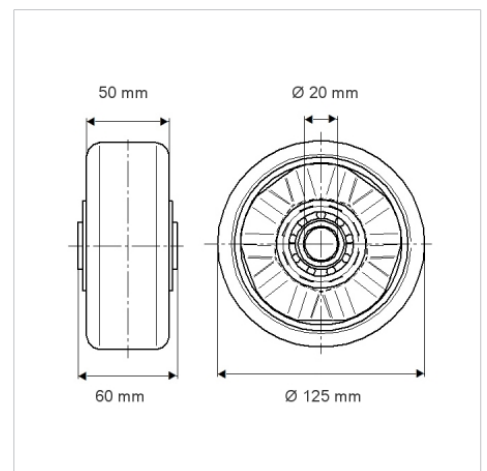

## Advantages at a glance

롤 저항성	● ● ● ○ ○
이동 소음	● ● ● ○ ○
마찰	● ● ● ● ○
부식 방지	● ● ● ○ ○

## Structure & Mounting

