

NOVATECH

ITP125x50-Ø20 flat

EAN 4031582070316

Riteņa centrs izgatavots no alumīnija, protektors: poliuretāns, izliets, augstas precizitātes lodīšu gultnis



BETTER MOBILITY. BETTER LIFE.



Picture may differ from original product

Tehniskie dati

Riteņa diametrs	125 mm
Riteņa platums	50 mm
Riteņa ass Ø	20 mm
Rumbas platums	60 mm
Temperatūra	- 10 / + 60 °C
Standarts	EN 12532
Svars	0.85 kg
Kontaktslāņa cietība	Shore D 42
Kravnesība - kustībā	500 kg
Kravnesība - miera stāvoklī	1000 kg

Dimensions

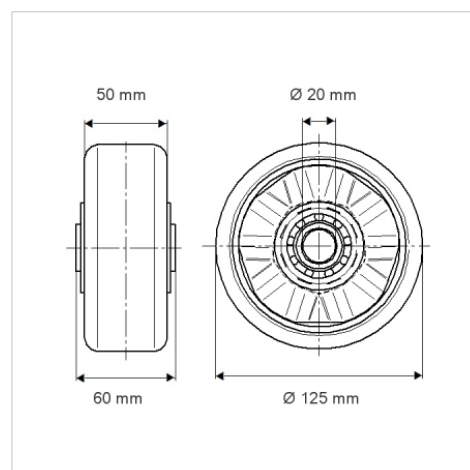

Advantages at a glance

Riteņa izturība	● ● ● ○ ○
Kustības troksnis	● ● ● ○ ○
Berze	● ● ● ● ○
Rūsēšanas aizsardzība	● ● ● ○ ○

Structure & Mounting

