

# NOVATECH

## ITP125x50-Ø20 flat

EAN 4031582070316

Wielkern van aluminium met gegoten polyurethaan loopvlak, precisiekogellagers



BETTER MOBILITY. BETTER LIFE.



Foto kan afwijken van het originele product

### Technische gegevens

Wieldiameter	125 mm
Wielbreedte	50 mm
Asgat-Ø	20 mm
Naaflengte	60 mm
Temperatuur	- 10 / + 60 °C
Standaard	EN 12532
Eigen gewicht	0.85 kg
Hardheid van de band	Shore D 42
Dyn. draagvermogen	500 kg
Statisch draagvermogen	1000 kg

### Afmetingen

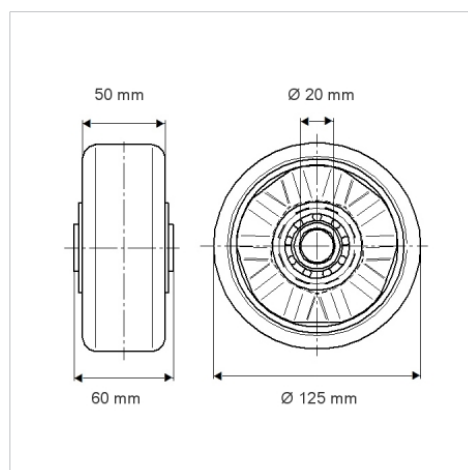

### Kenmerken

Rolweerstand	● ● ● ○ ○
Verplaatsingsgeluid	● ● ● ○ ○
Strepen	● ● ● ● ○
Roest bescherming	● ● ● ○ ○

### Structuur en montage

