

# NOVATECH

ITP200x50-Ø20 flat

EAN 4031582070330

Riteņa centrs izgatavots no alumīnija, protektors: poliuretāns, izliets, augstas precizitātes lodīšu gultnis



BETTER MOBILITY. BETTER LIFE.



Picture may differ from original product

## Tehniskie dati

Riteņa diametrs	200 mm
Riteņa platums	50 mm
Riteņa ass Ø	20 mm
Rumbas platums	60 mm
Temperatūra	- 10 / + 60 °C
Standarts	EN 12532
Svars	1.29 kg
Kontaktslāņa cietība	Shore D 42
Kravnesība - kustībā	800 kg
Kravnesība - miera stāvoklī	1600 kg

## Dimensions

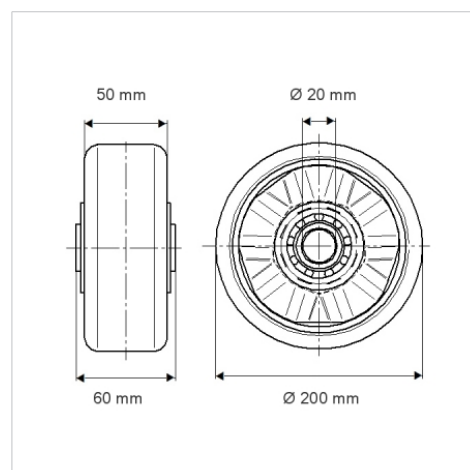

## Advantages at a glance

Riteņa izturība	● ● ● ○ ○
Kustības troksnis	● ● ● ○ ○
Berze	● ● ● ● ○
Rūsēšanas aizsardzība	● ● ● ○ ○

## Structure & Mounting

