

NOVATECH

ITP200x50-Ø20 flat

EAN 4031582070330

Wielkern van aluminium met gegoten polyurethaan loopvlak, precisiekogellagers



BETTER MOBILITY. BETTER LIFE.



Foto kan afwijken van het originele product

Technische gegevens

Wieldiameter	200 mm
Wielbreedte	50 mm
Asgat-Ø	20 mm
Naaflengte	60 mm
Temperatuur	- 10 / + 60 °C
Standaard	EN 12532
Eigen gewicht	1.29 kg
Hardheid van de band	Shore D 42
Dyn. draagvermogen	800 kg
Statisch draagvermogen	1600 kg

Afmetingen

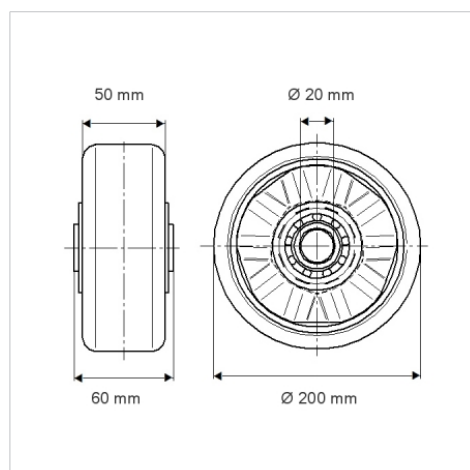

Kenmerken

Rolweerstand	● ● ● ○ ○
Verplaatsingsgeluid	● ● ● ○ ○
Strepen	● ● ● ● ○
Roest bescherming	● ● ● ○ ○

Structuur en montage

