

NOVATECH

ITP200x50-Ø20 flat

EAN 4031582070330

Wheel center made of Aluminum, Tread: Polyurethane, casted, precision ball bearing



BETTER MOBILITY. BETTER LIFE.



Picture may differ from original product

Technical Data

Wheel diameter	200 mm
Wheel width	50 mm
Axle Hole-Ø	20 mm
Hub length	60 mm
Temperature	- 10 / + 60 °C
Standard	EN 12532
Weight	1.29 kg
Hardness of tread	Shore D 42
Load capacity (dynamic)	800 kg
Load capacity (static)	1600 kg

Dimensions

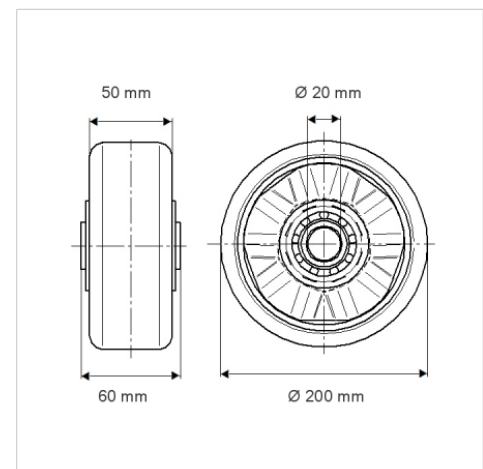

Structure & Mounting

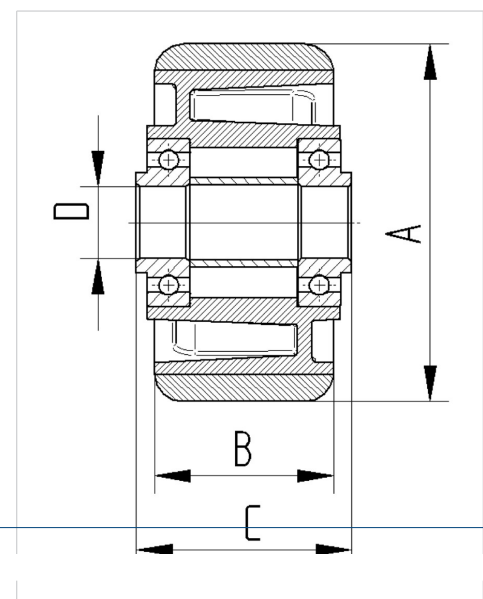

Advantages at a glance

Roll performance	● ● ● ○ ○
Movement noise	● ● ● ○ ○
Attrition	● ● ● ○ ○
Corrosion resistance	● ● ● ○ ○