

ELASTECH

JYC125x32-Ø8

EAN 4031582319965

Wheel center made of zinc-die-casting, Tread: solid rubber, black, non-staining, electric conductive, with threadguards, precision ball bearing, stainless



BETTER MOBILITY. BETTER LIFE.



Picture may differ from original product

Technical Data

Wheel diameter	125 mm
Wheel width	32 mm
Axle Hole-Ø	8.3 mm
Hub length	35.5 mm
Temperature	- 20 / + 85 °C
Standard	EN 12530
Weight	0.82 kg
Hardness of tread	Shore A 75
Load capacity (dynamic)	150 kg
Load capacity (static)	300 kg

Dimensions

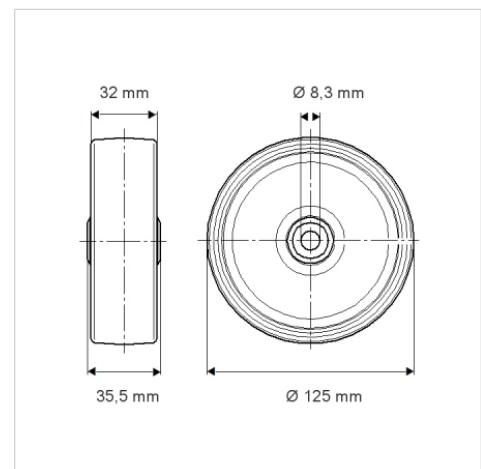

Advantages at a glance

Roll performance	● ● ● ○ ○
Movement noise	● ● ● ○ ○
Attrition	● ● ● ○ ○
Corrosion resistance	● ● ● ○ ○