

DURATECH PLUS

MOP160x50-Ø30

EAN 4031582320046

Wheel center made of Polyamide, extra-heavy duty model, precision ball bearing



BETTER MOBILITY. BETTER LIFE.



Picture may differ from original product

Technical Data

Wheel diameter	160 mm
Wheel width	50 mm
Axle Hole-Ø	30 mm
Hub length	60 mm
Temperature	- 40 / + 80 °C
Standard	EN 12533
Weight	1.616 kg
Hardness of tread	Shore D 75
Bearing	6306 No.
Load capacity (dynamic)	2250 kg
Load capacity (static)	4500 kg

Dimensions

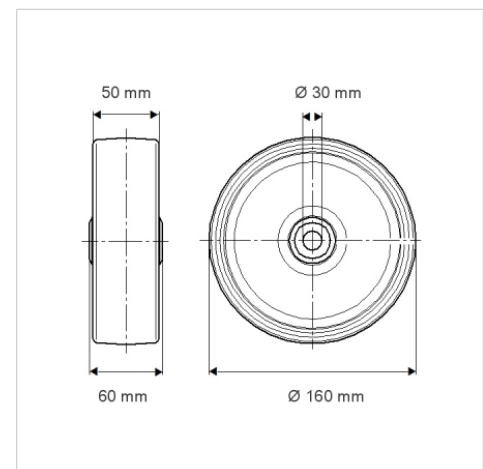

Structure & Mounting

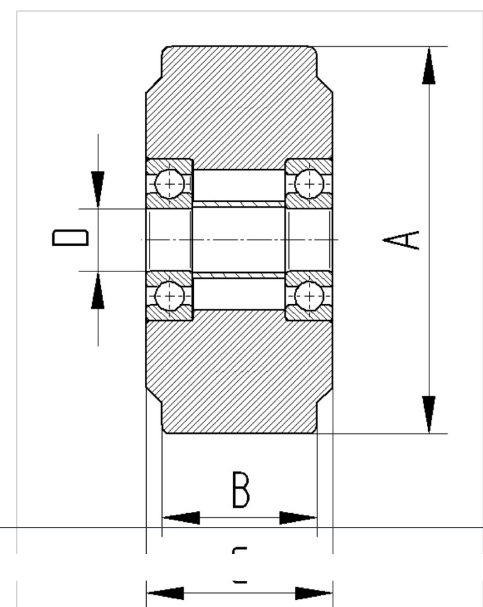

Advantages at a glance

Roll performance	● ● ● ● ●
Movement noise	● ● ● ○ ○
Attrition	● ● ● ● ●
Corrosion resistance	● ● ● ○ ○