

DURATECH PLUS

MOP200x50-Ø35

EAN 4031582320053

Wheel centre made of Polyamide, extra-heavy duty model, precision ball bearing



BETTER MOBILITY. BETTER LIFE.



Picture may differ from original product

Technical Data

Wheel diameter	200 mm
Wheel width	50 mm
Axle Hole-Ø	35 mm
Hub length	60 mm
Temperature	- 40 / + 80 °C
Standard	EN 12533
Weight	2.578 kg
Hardness of tread	Shore D 75
Bearing type	6307 No.
Load capacity	2800 kg
Load capacity (static)	5600 kg

Dimensions

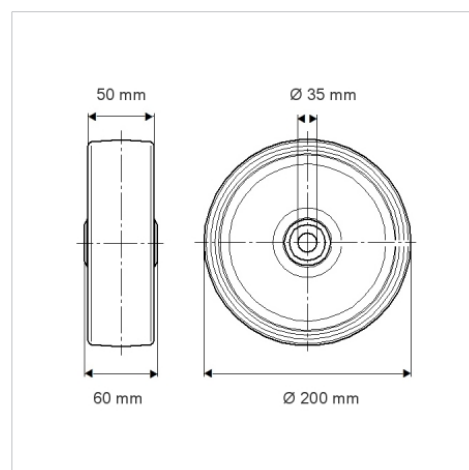

Advantages at a glance

Roll performance	● ● ● ● ●
Movement noise	● ● ● ○ ○
Attrition	● ● ● ● ●
Corrosion resistance	● ● ● ○ ○

Structure & Mounting

