

PURETECH

PIR200x50-Ø20

EAN 4031582320381

Hjulfælg: Polypropylen, Hjulbane: Massiv gummi, afsmitningsfri, rulleleje



BETTER MOBILITY. BETTER LIFE.



Illustrationen kan afvige fra originalen

Tekniske data

Hjul-Ø	200 mm
Hjulbredde	50 mm
Boring-Ø	20 mm
Navlængde	60 mm
Temperaturinterval	- 20 / + 60 °C
Standard	EN 12532
Vægt	1.538 kg
Hjulbane hårdhed	Shore A 80
Belastning (dynamisk)	205 kg
Belastning (statisk)	410 kg

Dimensioner

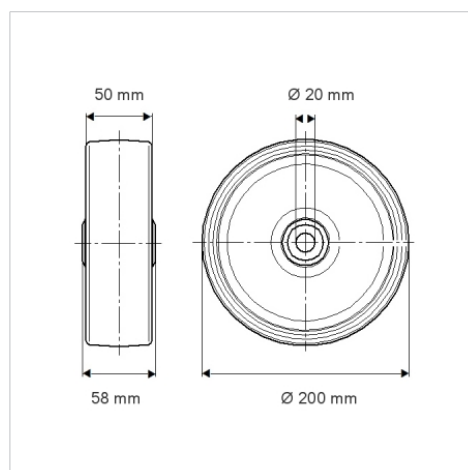

Egenskaber/fordele

Rullemodstand	● ● ● ○ ○
Kørselsstøj	● ● ● ○ ○
Slid	● ● ● ○ ○
Rustbeskyttelse	● ● ● ○ ○