

PURETECH

PIR200x50-Ø20

EAN 4031582320381

Telo tocka od polipropilena , Omotac: puna guma, siva - ne ostavlja trag , valjkasti lezaj

TENTE

BETTER MOBILITY. BETTER LIFE.



Picture may differ from original product

Tehnicki podaci

Precnik tocka.	200 mm
Sirina gazista.	50 mm
Otvor za osovinu Ø	20 mm
Duzina glavacine.	60 mm
Temperatura	- 20 / + 60 °C
Standard	EN 12532
Tezina	1.538 kg
Tvrdoca omotaca	Shore A 80
Dinamicka nosivost.	205 kg
Staticka nosivost.	410 kg

Dimensions

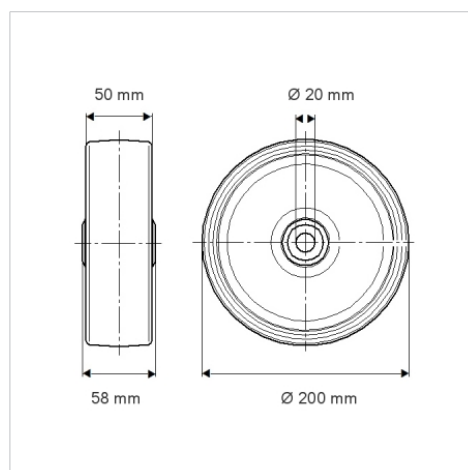

Advantages at a glance

Otpor okretanju	● ● ● ○ ○
Buka pri okretanju	● ● ● ○ ○
trenje , habanje	● ● ● ○ ○
zastita od korozije	● ● ● ○ ○