

SUPRATECH

PJO100x32-Ø12 HL44,4

EAN 4031582320411

Wheel center made of Polypropylene, Tread: TENTEprene (thermoplastic rubber), grey non-marking, plain bearing



BETTER MOBILITY. BETTER LIFE.



Picture may differ from original product

Technical Data

Wheel diameter	100 mm
Wheel width	32 mm
Axle Hole-Ø	12.3 mm
Hub length	44.4 mm
Temperature	- 20 / + 60 °C
Standard	EN 12532
Weight	0.129 kg
Hardness of tread	Shore A 87
Load capacity (dynamic)	80 kg
Load capacity (static)	160 kg

Dimensions

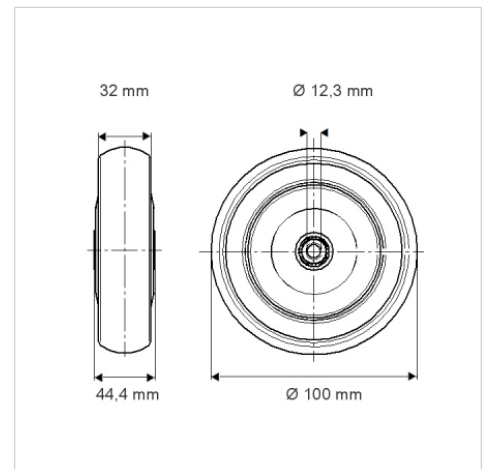

Advantages at a glance

Roll performance	● ● ● ○ ○
Movement noise	● ● ● ○ ○
Attrition	● ● ● ○ ○
Corrosion resistance	● ● ● ○ ○