

# SUPRATECH

PJO100x32-Ø12

EAN 4031582070224

Hjulfælg: Polypropylen, Hjulbane: TENTEprene, termoplastisk gummi, afsmitningsfri, glideleje



BETTER MOBILITY. BETTER LIFE.



Illustrationen kan afvige fra originalen

## Tekniske data

Hjul-Ø	100 mm
Hjulbredde	32 mm
Boring-Ø	12.3 mm
Navlængde	34.9 mm
Temperaturinterval	- 20 / + 60 °C
Standard	EN 12530
Vægt	0.126 kg
Hjulbane hårdhed	Shore A 87
Belastning (dynamisk)	80 kg
Belastning (statisk)	160 kg

## Dimensioner

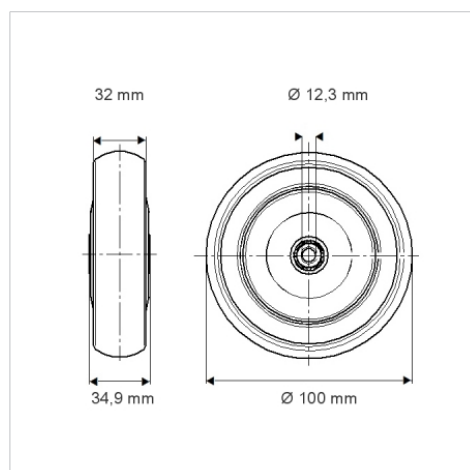

## Egenskaber/fordele

Rullemodstand	● ● ● ○ ○
Kørselsstøj	● ● ● ○ ○
Slid	● ● ● ○ ○
Rustbeskyttelse	● ● ● ○ ○