

SUPRATECH

PJR125x32-Ø12 HL34,9

EAN 4031582320534

Hjulfælg: Polypropylen, Hjulbane: TENTEprene, grå termoplastisk gummi, afsmitningsfri, rulleleje



BETTER MOBILITY. BETTER LIFE.



Illustrationen kan afvige fra originalen

Tekniske data

Hjul-Ø	125 mm
Hjulbredde	32 mm
Boring-Ø	12 mm
Navlængde	34.9 mm
Temperaturinterval	- 20 / + 60 °C
Standard	EN 12530
Vægt	0.239 kg
Hjulbane hårdhed	Shore A 87
Belastning (dynamisk)	100 kg
Belastning (statisk)	200 kg

Dimensioner

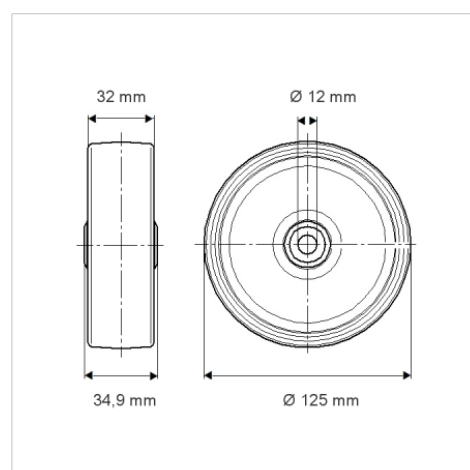

Egenskaber/fordele

Rullemodstand	● ● ● ○ ○
Kørselsstøj	● ● ● ○ ○
Slid	● ● ● ○ ○
Rustbeskyttelse	● ● ● ○ ○