

BASETECH

POO065x30-Ø12 RAL9011

EAN 4031582320718

Hjulfælg: Polypropylen, glideleje



BETTER MOBILITY. BETTER LIFE.



Illustrationen kan afvige fra originalen

Tekniske data

Hjul-Ø	65 mm
Hjulbredde	30 mm
Boring-Ø	12.1 mm
Navlængde	34.5 mm
Temperaturinterval	- 20 / + 60 °C
Standard	EN 12532
Vægt	0.047 kg
Hjulbane hårdhed	Shore D 65
Belastning (dynamisk)	120 kg
Belastning (statisk)	240 kg

Dimensioner

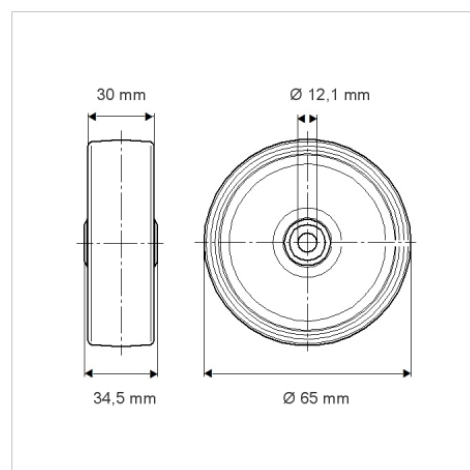

Egenskaber/fordele

Rullemodstand	● ● ● ○ ○
Kørselsstøj	● ● ● ○ ○
Slid	● ● ● ● ●
Rustbeskyttelse	● ● ● ○ ○