

BASETECH

POR080x34-Ø12 RAL9011

EAN 4031582320763

폴리프로필렌으로 만든 휠 중심, 롤러 베어링



BETTER MOBILITY. BETTER LIFE.



Picture may differ from original product

기술 데이터

휠 직경	80 mm
휠 폭	34 mm
축 홀-Ø	12 mm
허브 길이	44.4 mm
온도	- 20 / + 60 °C
표준	EN 12532
무게	0.102 kg
트레드 경도	Shore D 65
동하중	125 kg
정지하중	250 kg

Dimensions

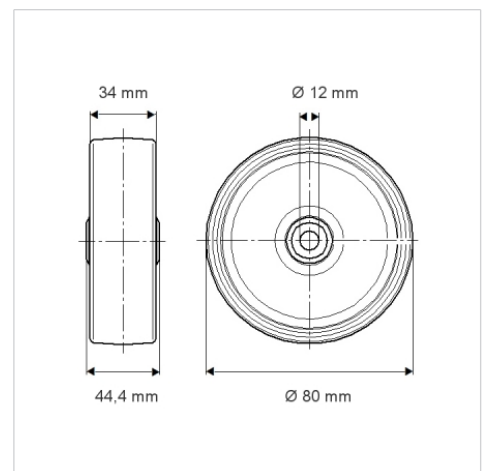

Advantages at a glance

롤 저항성	● ● ● ○ ○
이동 소음	● ● ● ○ ○
마찰	● ● ● ● ●
부식 방지	● ● ● ○ ○