

BASETECH

POR080x34-Ø12 RAL9011

EAN 4031582320763

wiel van polypropyleen, wielnaaf op rollager



BETTER MOBILITY. BETTER LIFE.



Foto kan afwijken van het originele product

Technische gegevens

Wieldiameter	80 mm
Wielbreedte	34 mm
Asgat-Ø	12 mm
Naaflengte	44.4 mm
Temperatuur	- 20 / + 60 °C
Standaard	EN 12532
Eigen gewicht	0.102 kg
Hardheid van de band	Shore D 65
Dyn. draagvermogen	125 kg
Statisch draagvermogen	250 kg

Afmetingen

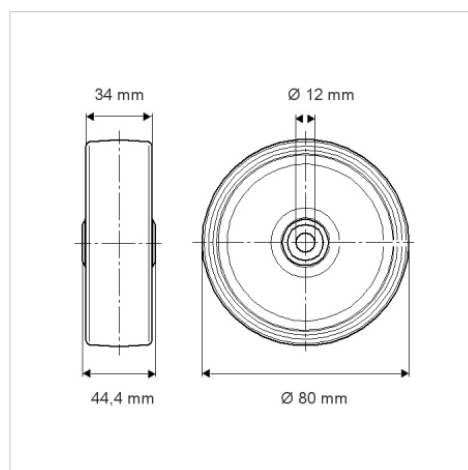

Kenmerken

Rolweerstand	● ● ● ○ ○
Verplaatsingsgeluid	● ● ● ○ ○
Strepen	● ● ● ● ●
Roest bescherming	● ● ● ○ ○