

PURETECH

PVR250x60-Ø25

EAN 4031582321340

Hjulfælg: Polypropylen, Hjulbane: Massiv sort gummi, rulleleje



BETTER MOBILITY. BETTER LIFE.



Illustrationen kan afvige fra originalen

Tekniske data

Hjul-Ø	250 mm
Hjulbredde	60 mm
Boring-Ø	25 mm
Navlængde	74 mm
Temperaturinterval	- 20 / + 60 °C
Standard	EN 12532
Vægt	2.872 kg
Hjulbane hårdhed	Shore A 80
Belastning (dynamisk)	295 kg
Belastning (statisk)	590 kg

Dimensioner

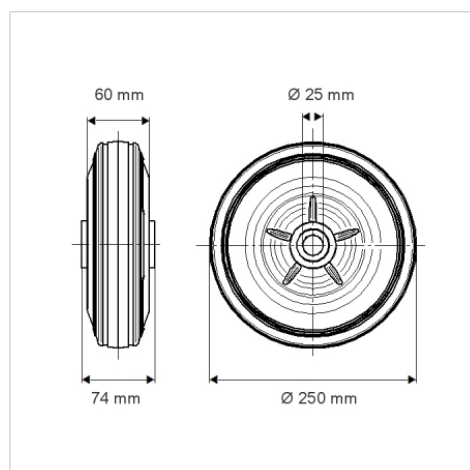

Egenskaber/fordele

Rullemodstand	● ● ● ○ ○
Kørselsstøj	● ● ● ○ ○
Slid	● ● ○ ○ ○
Rustbeskyttelse	● ● ● ○ ○