

PURETECH

PVR250x60-Ø25

EAN 4031582321340

Wheel centre made of Polypropylene, Tread: solid rubber, black, roller bearing



BETTER MOBILITY. BETTER LIFE.



Picture may differ from original product

Technical Data

Wheel diameter	250 mm
Wheel width	60 mm
Axle Hole-Ø	25 mm
Hub length	74 mm
Temperature	- 20 / + 60 °C
Standard	EN 12532
Weight	2.872 kg
Hardness of tread	Shore A 80
Load capacity	295 kg
Load capacity (static)	590 kg

Dimensions

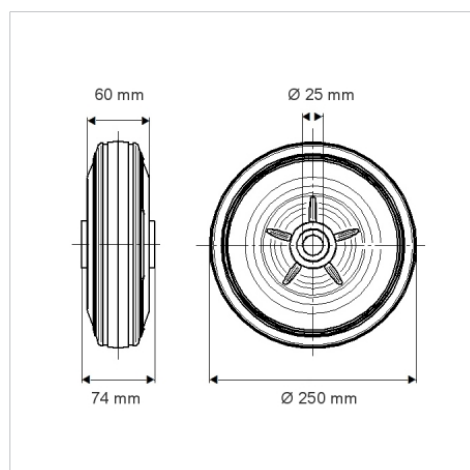

Advantages at a glance

Roll performance	● ● ● ○ ○
Movement noise	● ● ● ○ ○
Attrition	● ● ○ ○ ○
Corrosion resistance	● ● ● ○ ○