

## R40-23x23 / 11

EAN 4031582090208

plastic sockets (square)



BETTER MOBILITY. BETTER LIFE.



Picture may differ from original product

### Technical Data

Bolt-Ø	23 mm
Overall height	36 mm
Weight	0.008 kg
Collar-Ø	25.5 mm
Load capacity (dynamic)	40 kg
Load capacity (static)	80 kg

### Dimensions

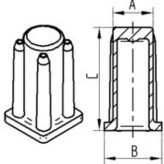

Bezeichnung	A	B	C
R40-16x16	16	20	36
R40-17x17	17	19	36
R40-18x18	18	20	36
R40-21x21	21	23,5	36
R40-22x22	22	24,5	36
R40-23x23	23	25,5	36
R40-26x26	26	30	36

### Advantages at a glance

Roll performance	○ ○ ○ ○ ○
Movement noise	○ ○ ○ ○ ○
Attrition	○ ○ ○ ○ ○
Corrosion resistance	● ● ● ○ ○