

R48-22,5-Ø18

EAN 4031582321739

casquillo reductor (cuadrado)



BETTER MOBILITY. BETTER LIFE.



La foto puede diferir del producto original

Datos técnicos

Diámetro de la espiga	18 mm
Altura de la espiga	62 mm
Peso de la rueda	0.014 kg

Ventajas en un vistazo

Resistencia a la rodadura	○ ○ ○ ○ ○
Ruido de movimiento	○ ○ ○ ○ ○
Desgaste	○ ○ ○ ○ ○
Protección contra el óxido	● ● ● ○ ○

Dimensiones

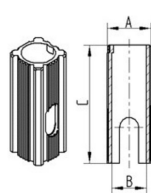

Bezeichnung	A	B	C
R48-225-Ø18	226	Ø18	62
R48-275-Ø18	275	Ø18	62
R48-27-Ø22	27	Ø22	45
R48-32-Ø22	32	Ø22	45
R48-36-Ø22	36	Ø22	60
R48-32-Ø28	32	Ø28	45
R48-3365-Ø28	3365	Ø28	45
R48-36-Ø28	36	Ø28	60