

## R48-27,5-Ø18

EAN 4031582321746

Firkantet reduktionshylse



BETTER MOBILITY. BETTER LIFE.



Illustrationen kan afvige fra originalen

### Tekniske data

Tap-Ø	18 mm
Taplængde	62 mm
Vægt	0.041 kg

### Egenskaber/fordele

Rullemodstand	○ ○ ○ ○ ○
Kørselsstøj	○ ○ ○ ○ ○
Slid	○ ○ ○ ○ ○
Rustbeskyttelse	● ● ● ○ ○

### Dimensioner

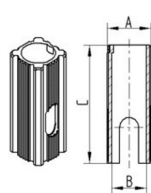

Bezeichnung	A	B	C
R48-225-Ø18	226	Ø18	62
R48-275-Ø18	275	Ø18	62
R48-27-Ø22	27	Ø22	45
R48-32-Ø22	32	Ø22	45
R48-36-Ø22	36	Ø22	60
R48-32-Ø28	32	Ø28	45
R48-3365-Ø28	3365	Ø28	45
R48-36-Ø28	36	Ø28	60