

## R48-33,65-Ø28

EAN 4031582321784

bucșă de reducere (pătrată)



BETTER MOBILITY. BETTER LIFE.



Picture may differ from original product

### Date Tehnice

Diametru bolț	28 mm
Lungime bolț	45 mm
Greutate	0.035 kg

### Advantages at a glance

Rezistență la rulare	○ ○ ○ ○ ○
Zgomot de mișcare	○ ○ ○ ○ ○
Uzare	○ ○ ○ ○ ○
Protecție împotriva ruginii	● ● ● ○ ○

### Dimensions

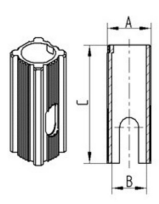

Bezeichnung	A	B	C
R48-225-Ø18	226	Ø18	62
R48-275-Ø18	275	Ø18	62
R48-27-Ø22	27	Ø22	45
R48-32-Ø22	32	Ø22	45
R48-36-Ø22	36	Ø22	60
R48-32-Ø28	32	Ø28	45
R48-3365-Ø28	3365	Ø28	45
R48-36-Ø28	36	Ø28	60