

NOVATECH

STP250x100-Ø35 HL120

EAN 4031582322231

Hjulfælg: Stål, lakeret, svær udførelse, Hjulbane: Polyuretan, DIN-kugleleje



BETTER MOBILITY. BETTER LIFE.



Illustrationen kan afvige fra originalen

Tekniske data

Hjul-Ø	250 mm
Hjulbredde	100 mm
Boring-Ø	35 mm
Navlængde	120 mm
Temperaturinterval	- 10 / + 60 °C
Standard	EN 12533
Vægt	18.321 kg
Hjulbane hårdhed	Shore D 42
Belastning (dynamisk)	2200 kg
Belastning (statisk)	4400 kg

Dimensioner

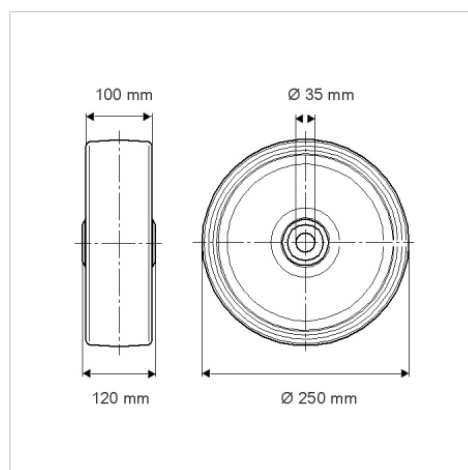

Egenskaber/fordele

Rullemodstand	● ● ● ○ ○
Kørselsstøj	● ● ● ○ ○
Slid	● ● ● ● ○
Rustbeskyttelse	● ● ● ○ ○

Struktur og montering

