

NOVATECH

STP300x100-Ø40 HL120

EAN 4031582322248

Wheel centre made of pressed steel, lacquered, heavy duty, Tread: Polyurethane, casted, precision ball bearing



BETTER MOBILITY. BETTER LIFE.



Picture may differ from original product

Technical Data

Wheel diameter	300 mm
Wheel width	100 mm
Axle Hole-Ø	40 mm
Hub length	120 mm
Temperature	- 10 / + 60 °C
Standard	EN 12533
Weight	22.968 kg
Hardness of tread	Shore D 42
Load capacity	2600 kg
Load capacity (static)	5200 kg

Dimensions

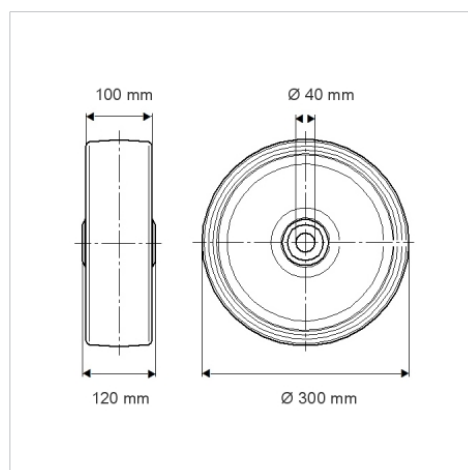

Advantages at a glance

Roll performance	● ● ● ○ ○
Movement noise	● ● ● ○ ○
Attrition	● ● ● ● ○
Corrosion resistance	● ● ● ○ ○

Structure & Mounting

