

# NOVATECH

STP400x100-Ø40 HL120

EAN 4031582322262

Hjulfælg: Stål, lakeret, svær udførelse, Hjulbane: Polyuretan, DIN-kugleleje



BETTER MOBILITY. BETTER LIFE.



Illustrationen kan afvige fra originalen

## Tekniske data

Hjul-Ø	400 mm
Hjulbredde	100 mm
Boring-Ø	40 mm
Navlængde	120 mm
Temperaturinterval	- 10 / + 60 °C
Standard	EN 12533
Vægt	34.031 kg
Hjulbane hårdhed	Shore D 42
Belastning (dynamisk)	3200 kg
Belastning (statisk)	6400 kg

## Dimensioner

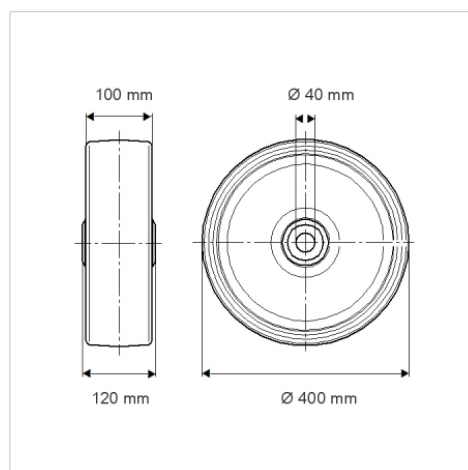

## Egenskaber/fordele

Rullemodstand	● ● ● ○ ○
Kørselsstøj	● ● ● ○ ○
Slid	● ● ● ● ○
Rustbeskyttelse	● ● ● ○ ○

## Struktur og montering

