

DURATECH

TOO100x50-Ø15

EAN 4031582322484

Wielkern van polyamide, wielnaaf op glijlager, Heavy Duty uitvoering



BETTER MOBILITY. BETTER LIFE.



Foto kan afwijken van het originele product

Technische gegevens

Wieldiameter	100 mm
Wielbreedte	50 mm
Asgat-Ø	15 mm
Naaflengte	60 mm
Temperatuur	- 40 / + 80 °C
Standaard	EN 12533
Eigen gewicht	0.388 kg
Hardheid van de band	Shore D 75
Dyn. draagvermogen	600 kg
Statisch draagvermogen	1200 kg

Afmetingen

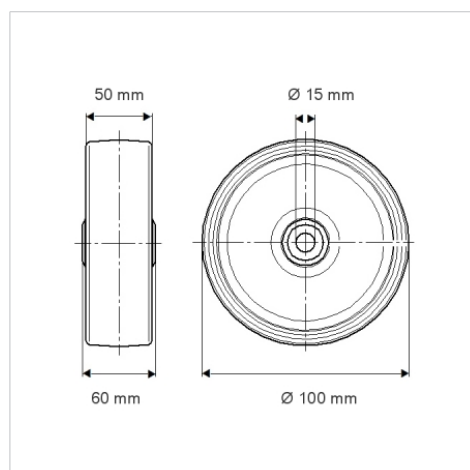

Kenmerken

Rolweerstand	● ● ● ○ ○
Verplaatsingsgeluid	● ● ● ○ ○
Strepen	● ● ● ● ●
Roest bescherming	● ● ● ○ ○

Structuur en montage

