

DURATECH

TOO125x50-Ø15

EAN 4031582322507

Hjulfælg: Polyamid, svær udførelse, glideleje



BETTER MOBILITY. BETTER LIFE.



Illustrationen kan afvige fra originalen

Tekniske data

Hjul-Ø	125 mm
Hjulbredde	50 mm
Boring-Ø	15 mm
Navlængde	60 mm
Temperaturinterval	- 40 / + 80 °C
Standard	EN 12533
Vægt	0.536 kg
Hjulbane hårdhed	Shore D 75
Belastning (dynamisk)	700 kg
Belastning (statisk)	1400 kg

Dimensioner

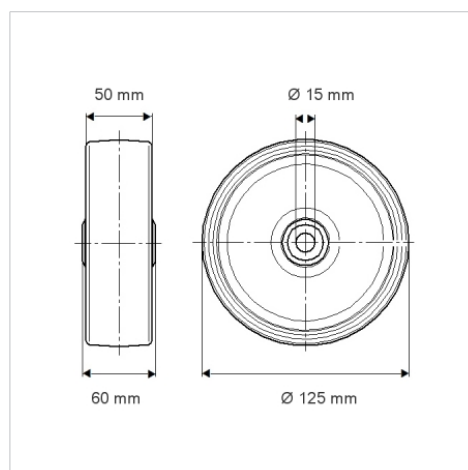

Egenskaber/fordele

Rullemodstand	● ● ● ○ ○
Kørselsstøj	● ● ● ○ ○
Slid	● ● ● ● ●
Rustbeskyttelse	● ● ● ○ ○

Struktur og montering

