

DURATECH

TOO150x50-Ø20

EAN 4031582322521

Riteņa centrs izgatavots no poliamīda, paredzēts lielai slodzei, vienkāršais gultnis



BETTER MOBILITY. BETTER LIFE.



Picture may differ from original product

Tehniskie dati

Riteņa diametrs	150 mm
Riteņa platums	50 mm
Riteņa ass Ø	20 mm
Rumbas platums	60 mm
Temperatūra	- 40 / + 80 °C
Standarts	EN 12533
Svars	0.731 kg
Kontaktslāņa cietība	Shore D 75
Kravnesība - kustībā	800 kg
Kravnesība - miera stāvoklī	1600 kg

Dimensions

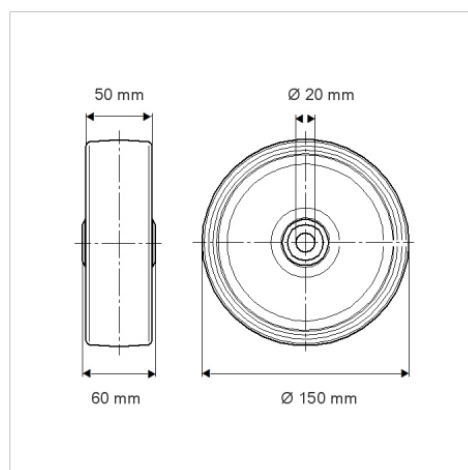

Advantages at a glance

Riteņa izturība	● ● ● ○ ○
Kustības troksnis	● ● ● ○ ○
Berze	● ● ● ● ●
Rūsēšanas aizsardzība	● ● ● ○ ○

Structure & Mounting

