

# DURATECH

TOO150x50-Ø20

EAN 4031582322521

Wheel center made of Polyamide, heavy duty, plain bearing



BETTER MOBILITY. BETTER LIFE.



Picture may differ from original product

## Technical Data

Wheel diameter	150 mm
Wheel width	50 mm
Axle Hole-Ø	20 mm
Hub length	60 mm
Temperature	- 40 / + 80 °C
Standard	EN 12533
Weight	0.731 kg
Hardness of tread	Shore D 75
Load capacity (dynamic)	800 kg
Load capacity (static)	1600 kg

## Dimensions

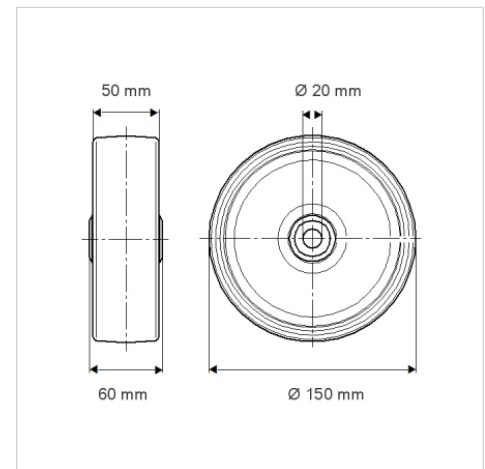

## Advantages at a glance

Roll performance	● ● ● ○ ○
Movement noise	● ● ● ○ ○
Attrition	● ● ● ● ●
Corrosion resistance	● ● ● ○ ○

## Structure & Mounting

