

DURATECH

TOO250x50-Ø25

EAN 4031582322569

Wheel centre made of Polyamide, heavy duty, plain bearing



BETTER MOBILITY. BETTER LIFE.



Picture may differ from original product

Technical Data

Wheel diameter	250 mm
Wheel width	50 mm
Axle Hole-Ø	25 mm
Hub length	60 mm
Temperature	- 40 / + 80 °C
Standard	EN 12533
Weight	1.54 kg
Hardness of tread	Shore D 75
Load capacity	1100 kg
Load capacity (static)	2200 kg

Dimensions

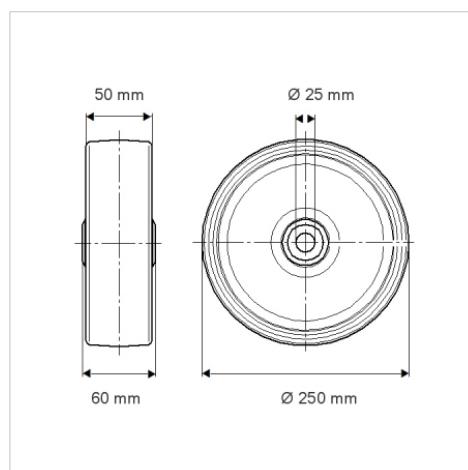

Advantages at a glance

Roll performance	● ● ● ○ ○
Movement noise	● ● ● ○ ○
Attrition	● ● ● ● ●
Corrosion resistance	● ● ● ○ ○

Structure & Mounting

