

DURATECH

TOO250x50-Ø25

EAN 4031582322569

Riteņa centrs izgatavots no poliamīda, paredzēts lielai slodzei, vienkāršais gultnis



BETTER MOBILITY. BETTER LIFE.



Picture may differ from original product

Tehniskie dati

Riteņa diametrs	250 mm
Riteņa platums	50 mm
Riteņa ass Ø	25 mm
Rumbas platums	60 mm
Temperatūra	- 40 / + 80 °C
Standarts	EN 12533
Svars	1.54 kg
Kontaktslāņa cietība	Shore D 75
Kravnesība - kustībā	1100 kg
Kravnesība - miera stāvoklī	2200 kg

Dimensions

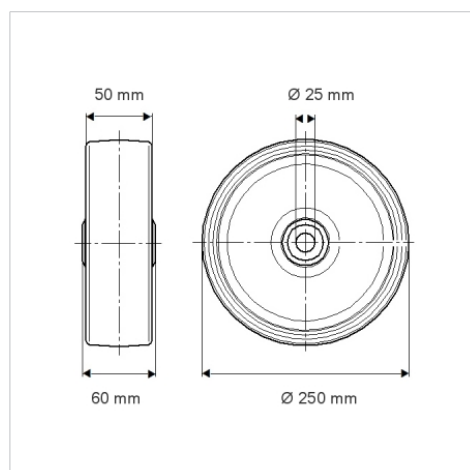

Advantages at a glance

Riteņa izturība	● ● ● ○ ○
Kustības troksnis	● ● ● ○ ○
Berze	● ● ● ● ●
Rūsēšanas aizsardzība	● ● ● ○ ○

Structure & Mounting

