

DURATECH

TOO250x50-Ø25

EAN 4031582322569

Wielkern van polyamide, wielnaaf op glijlager, Heavy Duty uitvoering



BETTER MOBILITY. BETTER LIFE.



Foto kan afwijken van het originele product

Technische gegevens

Wieldiameter	250 mm
Wielbreedte	50 mm
Asgat-Ø	25 mm
Naaf lengte	60 mm
Temperatuur	- 40 / + 80 °C
Standaard	EN 12533
Eigen gewicht	1.54 kg
Hardheid van de band	Shore D 75
Dyn. draagvermogen	1100 kg
Statisch draagvermogen	2200 kg

Afmetingen

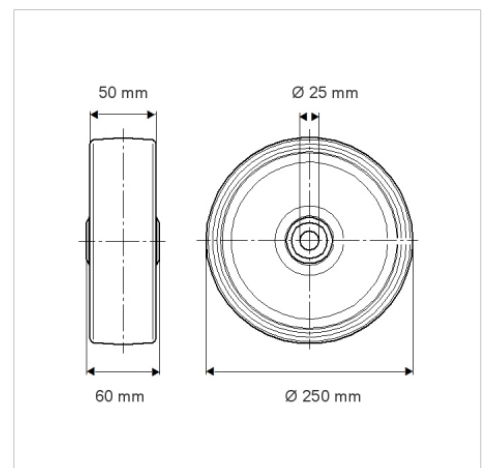

Kenmerken

Rolweerstand	● ● ● ○ ○
Verplaatsingsgeluid	● ● ● ○ ○
Strepen	● ● ● ● ●
Roest bescherming	● ● ● ○ ○

Structuur en montage

