

DURATECH

TOP100x50-Ø20

EAN 4031582322675

Wielkern van polyamide, wielnaaf op precisiekogellager, Heavy Duty uitvoering



BETTER MOBILITY. BETTER LIFE.



Foto kan afwijken van het originele product

Technische gegevens

Wieldiameter	100 mm
Wielbreedte	50 mm
Asgat-Ø	20 mm
Naaf lengte	60 mm
Temperatuur	- 40 / + 80 °C
Standaard	EN 12533
Eigen gewicht	0.527 kg
Hardheid van de band	Shore D 75
Lager	6004 Nr.
Dyn. draagvermogen	600 kg
Statisch draagvermogen	1200 kg

Afmetingen

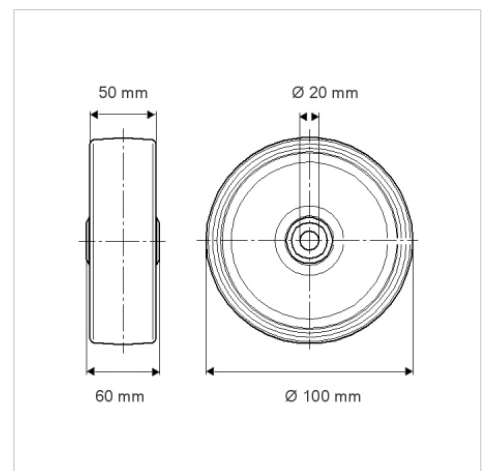

Kenmerken

Rolweerstand	● ● ● ● ●
Verplaatsingsgeluid	● ● ● ○ ○
Strepen	● ● ● ● ●
Roest bescherming	● ● ● ○ ○

Structuur en montage

