

# DURATECH

TOP125x50-Ø20

EAN 4031582322682

Wheel centre made of Polyamide, heavy duty, precision ball bearing



BETTER MOBILITY. BETTER LIFE.



Picture may differ from original product

## Technical Data

Wheel diameter	125 mm
Wheel width	50 mm
Axle Hole-Ø	20 mm
Hub length	60 mm
Temperature	- 40 / + 80 °C
Standard	EN 12533
Weight	0.805 kg
Hardness of tread	Shore D 75
Bearing type	6204 No.
Load capacity	700 kg
Load capacity (static)	1400 kg

## Dimensions

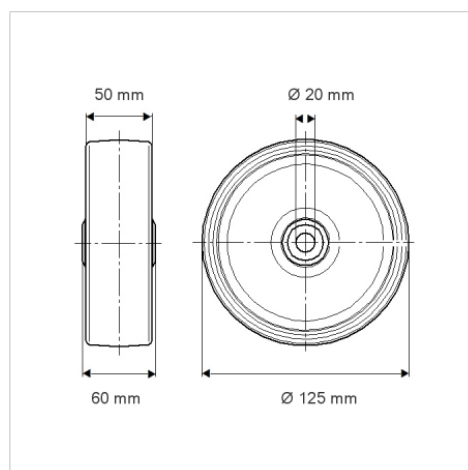

## Advantages at a glance

Roll performance	● ● ● ● ●
Movement noise	● ● ● ○ ○
Attrition	● ● ● ● ●
Corrosion resistance	● ● ● ○ ○

## Structure & Mounting

