

DURATECH

TOP150x50-Ø20

EAN 4031582322699

Hjulfælg: Polyamid, svær udførelse, DIN-kugleleje



BETTER MOBILITY. BETTER LIFE.



Illustrationen kan afvige fra originalen

Tekniske data

Hjul-Ø	150 mm
Hjulbredde	50 mm
Boring-Ø	20 mm
Navlængde	60 mm
Temperaturinterval	- 40 / + 80 °C
Standard	EN 12533
Vægt	0.998 kg
Hjulbane hårdhed	Shore D 75
Hjulleje	6204 Nr.
Belastning (dynamisk)	800 kg
Belastning (statisk)	1600 kg

Dimensioner

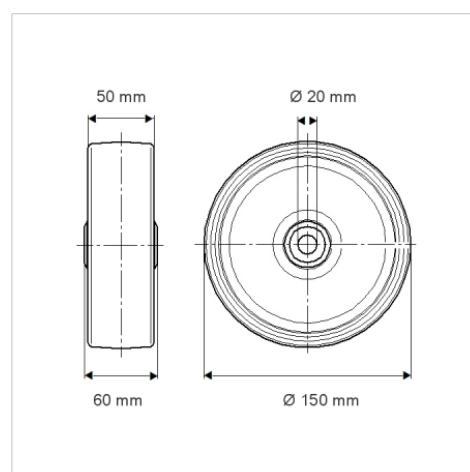

Egenskaber/fordele

Rullemodstand	● ● ● ● ●
Kørselsstøj	● ● ● ○ ○
Slid	● ● ● ● ●
Rustbeskyttelse	● ● ● ○ ○

Struktur og montering

