

DURATECH

TOP150x50-Ø20

EAN 4031582322699

Wheel center made of Polyamide, heavy duty, precision ball bearing



BETTER MOBILITY. BETTER LIFE.



Picture may differ from original product

Technical Data

Wheel diameter	150 mm
Wheel width	50 mm
Axle Hole-Ø	20 mm
Hub length	60 mm
Temperature	- 40 / + 80 °C
Standard	EN 12533
Weight	0.998 kg
Hardness of tread	Shore D 75
Bearing	6204 No.
Load capacity (dynamic)	800 kg
Load capacity (static)	1600 kg

Dimensions

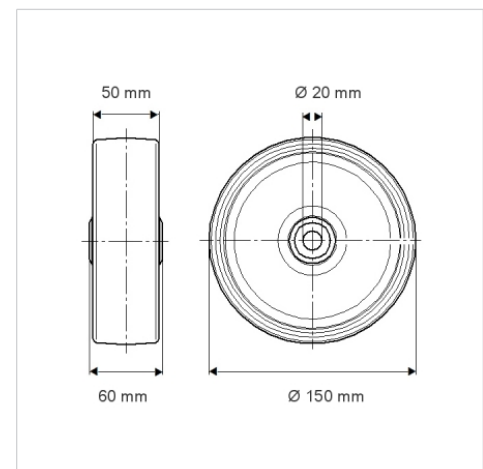

Structure & Mounting

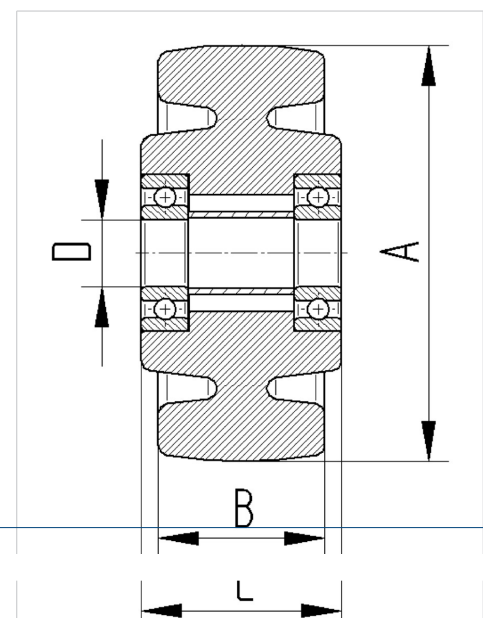

Advantages at a glance

Roll performance	● ● ● ● ●
Movement noise	● ● ● ○ ○
Attrition	● ● ● ● ●
Corrosion resistance	● ● ● ○ ○