

DURATECH

TOP160x50-Ø20

EAN 4031582322705

폴리아미드로 만든 휠 중심, 고하중, 정밀 볼 베어링



BETTER MOBILITY. BETTER LIFE.



Picture may differ from original product

기술 데이터

휠 직경	160 mm
휠 폭	50 mm
축 홀-Ø	20 mm
허브 길이	60 mm
온도	- 40 / + 80 °C
표준	EN 12533
무게	1.136 kg
트레드 경도	Shore D 75
베어링	6204 No.
동하중	850 kg
정지하중	1700 kg

Dimensions

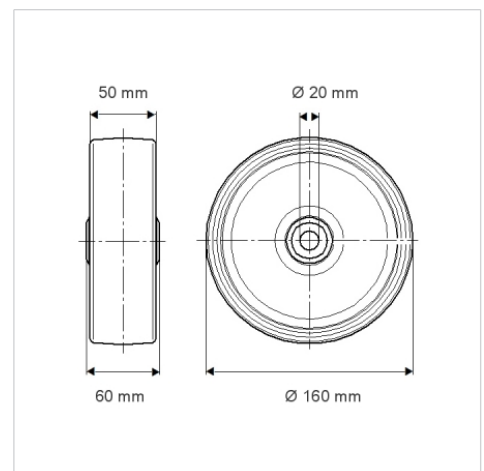

Advantages at a glance

롤 저항성	● ● ● ● ●
이동 소음	● ● ● ○ ○
마찰	● ● ● ● ●
부식 방지	● ● ● ○ ○

Structure & Mounting

