

# DURATECH

TOP200x50-Ø20

EAN 4031582322729

Wheel center made of Polyamide, heavy duty, precision ball bearing



BETTER MOBILITY. BETTER LIFE.



Picture may differ from original product

## Technical Data

Wheel diameter	200 mm
Wheel width	50 mm
Axle Hole-Ø	20 mm
Hub length	60 mm
Temperature	- 40 / + 80 °C
Standard	EN 12533
Weight	1.624 kg
Hardness of tread	Shore D 75
Bearing	6304 No.
Load capacity (dynamic)	800 kg
Load capacity (static)	1600 kg

## Dimensions

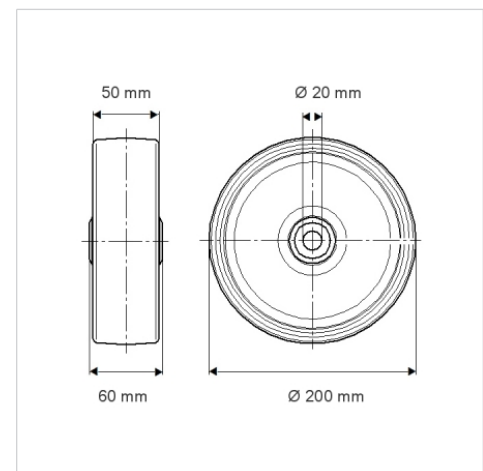

## Structure & Mounting

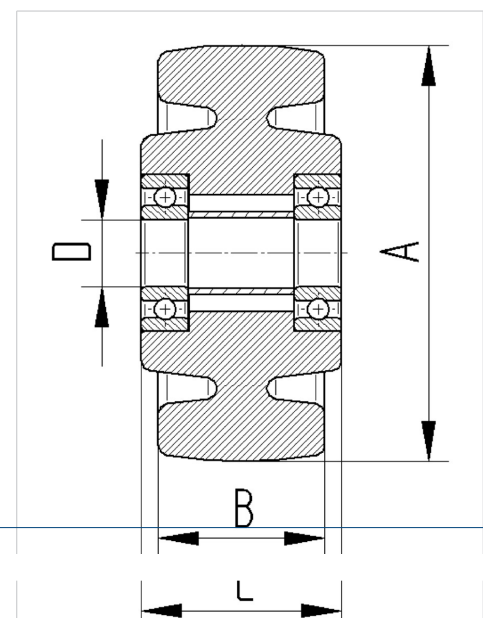

## Advantages at a glance

Roll performance	● ● ● ● ●
Movement noise	● ● ● ○ ○
Attrition	● ● ● ● ●
Corrosion resistance	● ● ● ○ ○