

# DURATECH

## TOP200x50-Ø20

EAN 4031582322729

Telo tocka od poliamida, visoke nosivosti, precizni kuglicni lezaj

**TENTE**

BETTER MOBILITY. BETTER LIFE.



Picture may differ from original product

### Tehnicki podaci

Precnik tocka.	200 mm
Sirina gazista.	50 mm
Otvor za osovinu Ø	20 mm
Duzina glavcine.	60 mm
Temperatura	- 40 / + 80 °C
Standard	EN 12533
Tezina	1.624 kg
Tvrdoca omotaca	Shore D 75
Bearing	6304 Br.
Dinamicka nosivost.	800 kg
Staticka nosivost.	1600 kg

### Advantages at a glance

Otpor okretanju	● ● ● ● ●
Buka pri okretanju	● ● ● ○ ○
trenje , habanje	● ● ● ● ●
zastita od korozije	● ● ● ○ ○

### Dimensions

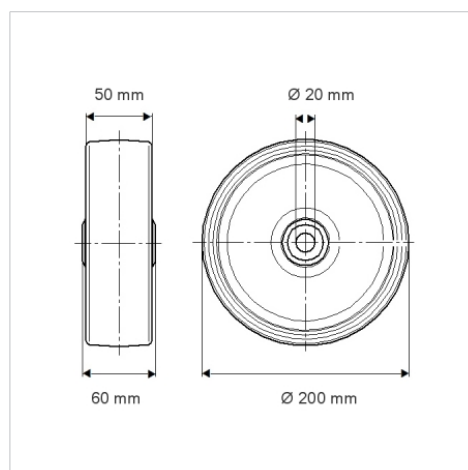

### Structure & Mounting

