

DURATECH

TOP200x50-Ø25

EAN 4031582322736

Wheel centre made of Polyamide, heavy duty, precision ball bearing



BETTER MOBILITY. BETTER LIFE.



Picture may differ from original product

Technical Data

Wheel diameter	200 mm
Wheel width	50 mm
Axle Hole-Ø	25 mm
Hub length	60 mm
Temperature	- 40 / + 80 °C
Standard	EN 12533
Weight	1.599 kg
Hardness of tread	Shore D 75
Bearing type	6205 No.
Load capacity	800 kg
Load capacity (static)	1600 kg

Dimensions

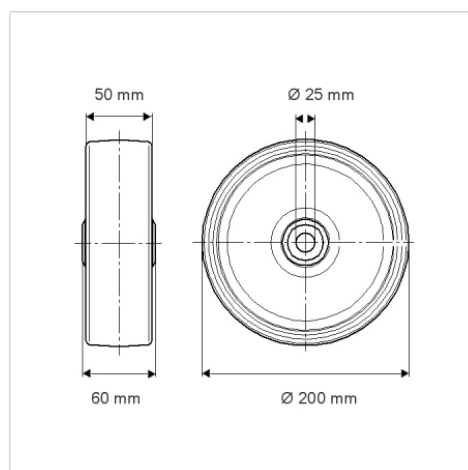

Advantages at a glance

Roll performance	● ● ● ● ●
Movement noise	● ● ● ○ ○
Attrition	● ● ● ● ●
Corrosion resistance	● ● ● ○ ○

Structure & Mounting

