

MAXTECH

UAP150x32-Ø8

EAN 4031582322972

Hjulfælg: Polyamid, Hjulbane: Polyuretan, DIN-kugleleje



BETTER MOBILITY. BETTER LIFE.



Illustrationen kan afvige fra originalen

Tekniske data

Hjul-Ø	150 mm
Hjulbredde	32 mm
Boring-Ø	8.3 mm
Navlængde	36.5 mm
Temperaturinterval	- 25 / + 80 °C
Standard	EN 12530
Vægt	0.443 kg
Hjulbane hårdhed	Shore D 40
Belastning (dynamisk)	160 kg
Belastning (statisk)	320 kg

Dimensioner

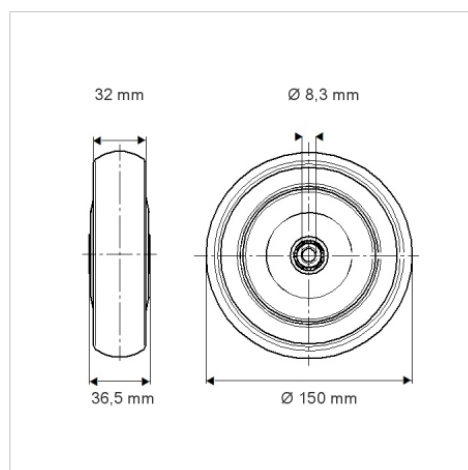

Egenskaber/fordele

Rullemodstand	● ● ● ○ ○
Kørselsstøj	● ● ● ○ ○
Slid	● ● ● ● ○
Rustbeskyttelse	● ● ● ○ ○