

MAXTECH

UAP150x32-Ø8

EAN 4031582322972

Jantă din poliamidă suprafață de rulare din poliuretan, rulment de precizie cu bile, etanșat



BETTER MOBILITY. BETTER LIFE.



Picture may differ from original product

Date Tehnice

Diametrul roții	150 mm
Lățimea roții	32 mm
Alezaj butuc	8.3 mm
Lungime butuc	36.5 mm
Temperatura	- 25 / + 80 °C
Standard	EN 12530
Greutate	0.443 kg
Rigiditatea suprafeței de rulare	Shore D 40
Sarcină dinamică	160 kg
Sarcină statică	320 kg

Dimensions

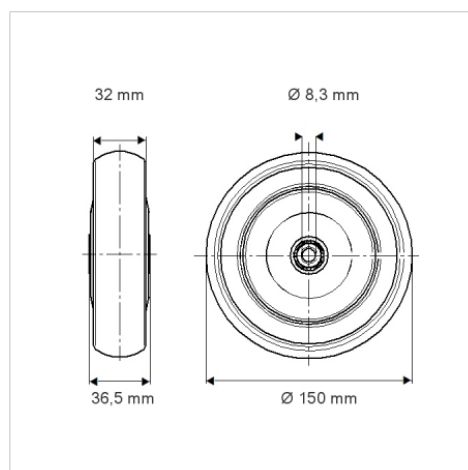

Advantages at a glance

Rezistență la rulare	● ● ● ○ ○
Zgomot de mișcare	● ● ● ○ ○
Uzare	● ● ● ● ○
Protecție împotriva ruginii	● ● ● ○ ○