

MAXTECH

UAP200x32-Ø8

EAN 4031582323023

Wheel centre made of Polyamide, Tread: Polyurethane, precision ball bearing



BETTER MOBILITY. BETTER LIFE.



Picture may differ from original product

Technical Data

Wheel diameter	200 mm
Wheel width	32 mm
Axle Hole-Ø	8.1 mm
Hub length	36.5 mm
Temperature	- 25 / + 80 °C
Standard	EN 12532
Weight	0.777 kg
Hardness of tread	Shore D 40
Load capacity	160 kg
Load capacity (static)	320 kg

Dimensions

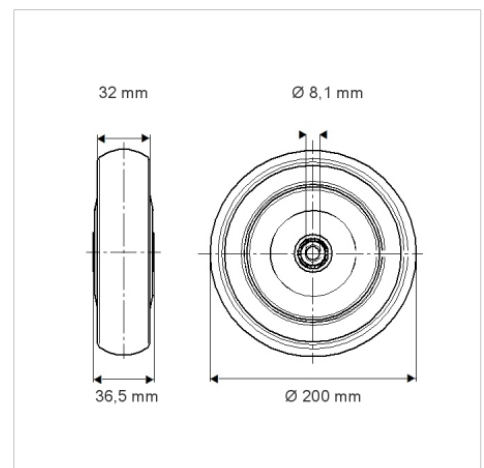

Advantages at a glance

Roll performance	● ● ● ○ ○
Movement noise	● ● ● ○ ○
Attrition	● ● ● ● ○
Corrosion resistance	● ● ● ○ ○