

# MAXTECH

UAR080x38-Ø12 HL44,4 grey

EAN 4031582323085

Wheel center made of Polyamide, Tread: Polyurethane, roller bearing



BETTER MOBILITY. BETTER LIFE.



Picture may differ from original product

## Technical Data

Wheel diameter	80 mm
Wheel width	38 mm
Axle Hole-Ø	12 mm
Hub length	44.4 mm
Temperature	- 25 / + 80 °C
Standard	EN 12532
Weight	0.192 kg
Hardness of tread	Shore D 42
Load capacity (dynamic)	150 kg
Load capacity (static)	300 kg

## Dimensions

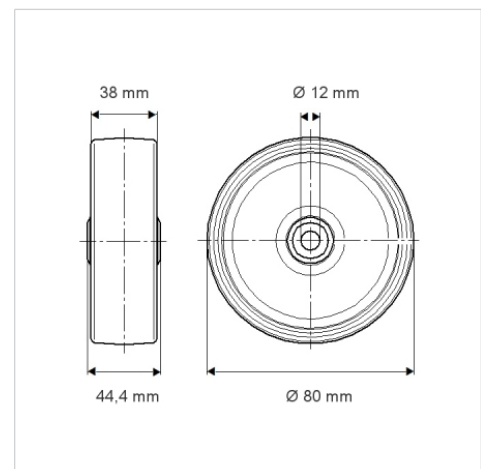

## Advantages at a glance

Roll performance	● ● ● ○ ○
Movement noise	● ● ● ○ ○
Attrition	● ● ● ○ ○
Corrosion resistance	● ● ● ○ ○